

High Vacuum Systems
MX80-003-01
00-09-13

Nederman[®]
Improving your workspace

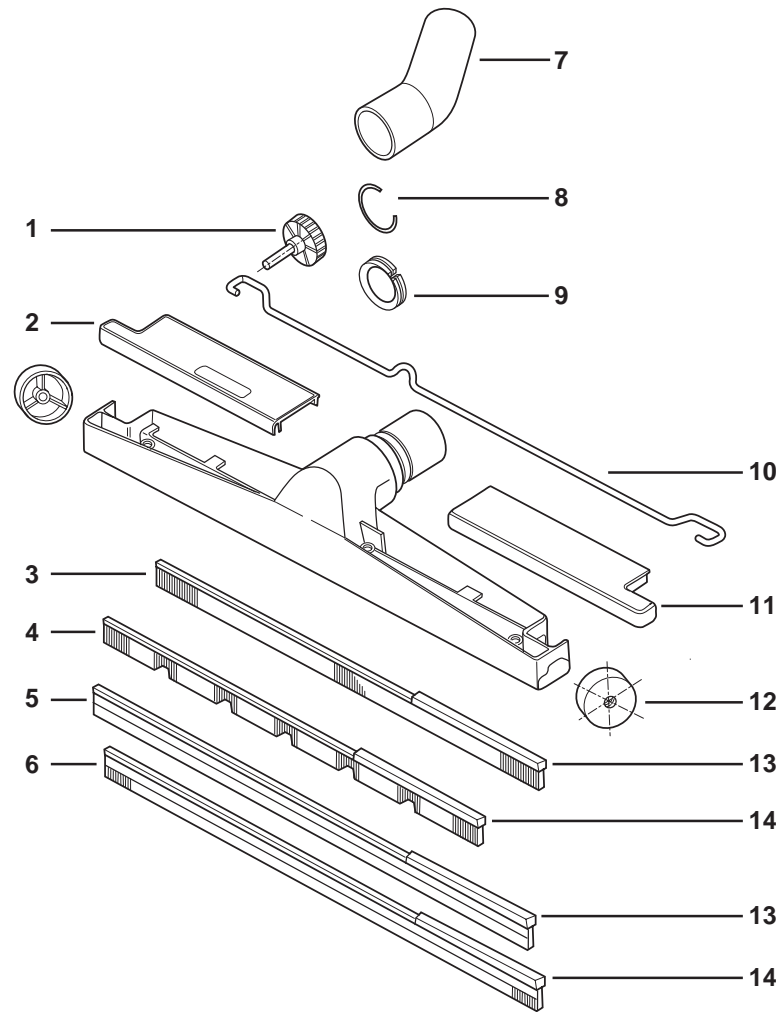

FLOOR NOZZLE 500

Reservdelista - Spare Parts List - Ersatzteilliste
Liste de pieces detachées - Lista de recambios

No	Part No	Qty	Benämning	Description	Benennung	Désignation	Descripcion
1	40 1960 60	1	Justerskruv	Adjustment screw			
2	40 1961 60	1	Täcklock Hö 500	Cover, right 500			
3	40 1958 80	1	Bakre borst, slät 500	Bristles, rear 500			
4	40 1958 90	1	Främre borst, tandad 500	Bristles, front 500			
5	40 1961 30	1	Gummiläpp, bak 500	Rubber blade, rear 500			
"	40 1962 71	1	Gummiläpp, L=4000 mm	Rubber blade, L=4000 mm			
6	40 1961 40	1	Gummiläpp, fram 500	Rubber blade, front 500			
"	40 1962 71	1	Gummiläpp, L=4000 mm	Rubber blade, L=4000 mm			
7	40 1961 20	1	Anslutning Ø 50 mm	Swivel Connection Ø 50 mm			
8	40 1961 10	1	Låsring Ø 50 mm	Locking ring Ø 50 mm			
9	40 1961 00	1	Plastring Ø 50 mm	Plastic ring Ø 50 mm			
10	40 1961 70	1	Bygel 500	Clamp 500			
11	40 1961 50	1	Täcklock Vä 500	Cover, left 500			
12	40 1960 20	2	Hjul	Wheel			
13	40 1962 50	2	Fästskena, bak 500	Holder, GRD 500, rear			
14	40 1962 60	2	Fästskena, fram 500	Holder, GRD 500, front			